

평면도
scale : None

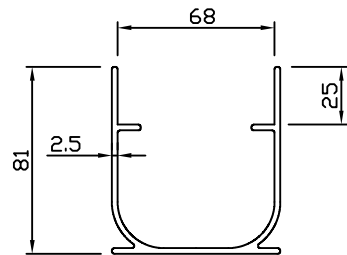

정면도
scale : None

타공커버

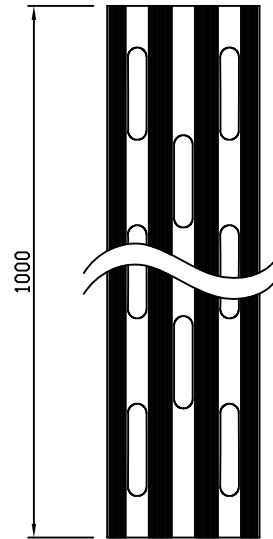

평면도
scale : None

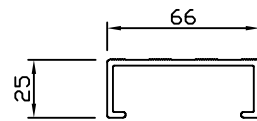

정면도
scale : None

연결소켓

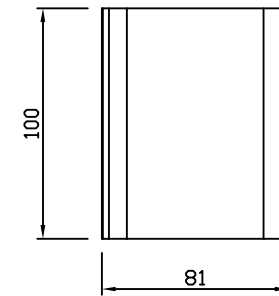

평면도
scale : None



정면도
scale : None

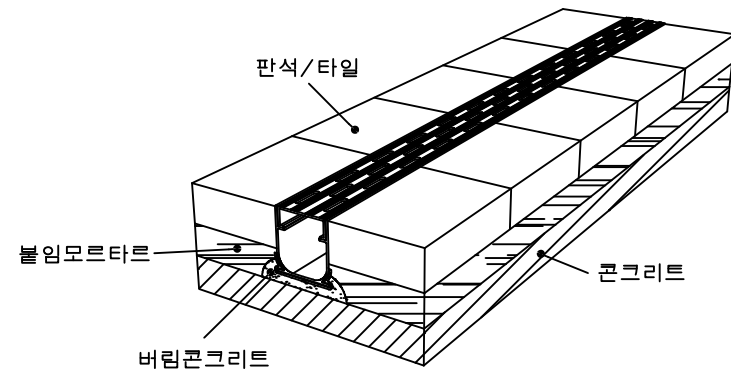

설치예시도 1
scale : None

PROJECT TITLE	품도양	SUBJECT TITLE	DATE
MATERIAL	WEIGHT	SIZE	73*81*3000
	Kg		

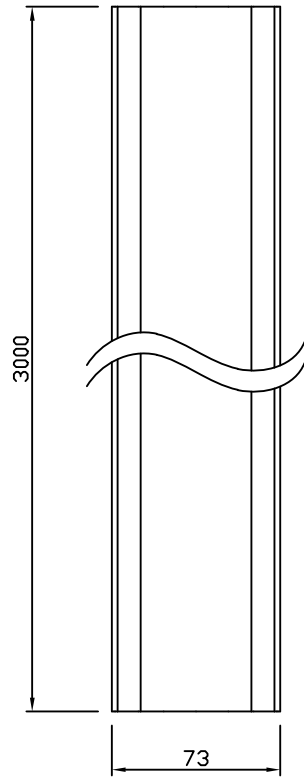

평면도
scale : None

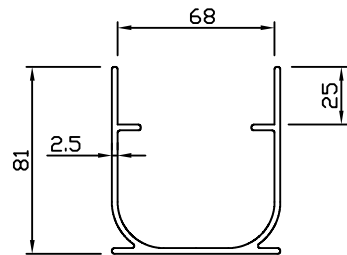

정면도
scale : None

데크그레이팅

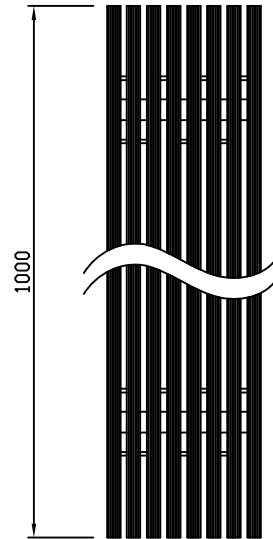

평면도
scale : None

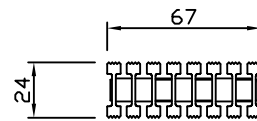

정면도
scale : None

연결소켓

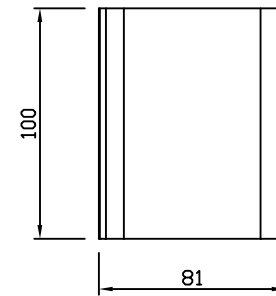

평면도
scale : None



정면도
scale : None

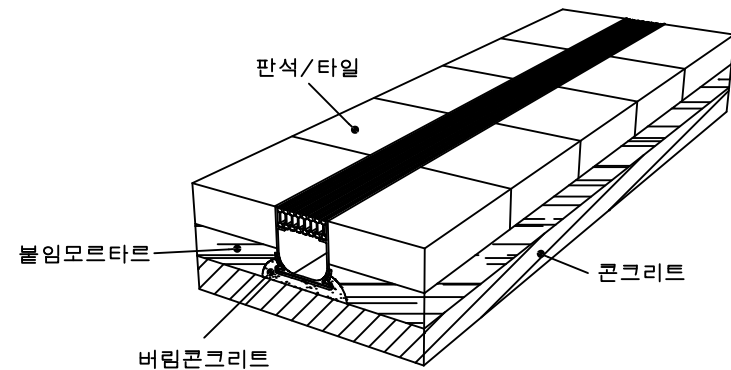

설치예시도 1
scale : None

PROJECT TITLE	품도양	SUBJECT TITLE	DATE	NOTE.
MATERIAL		WEIGHT	SIZE	
		Kg	73*81*3000	

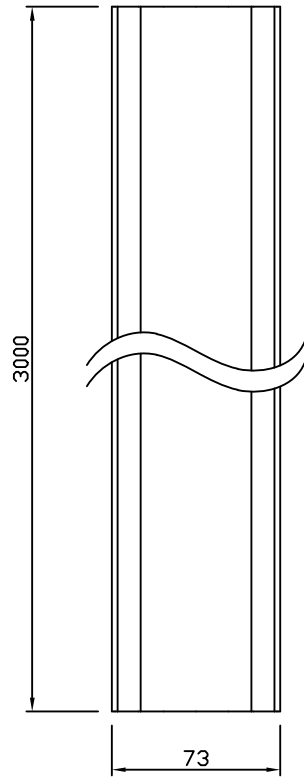

평면도
scale : None

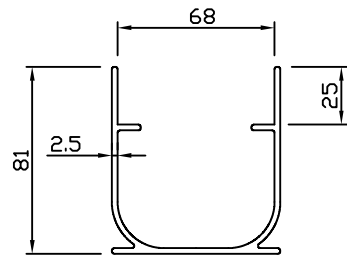

정면도
scale : None

주철디자인그레이팅

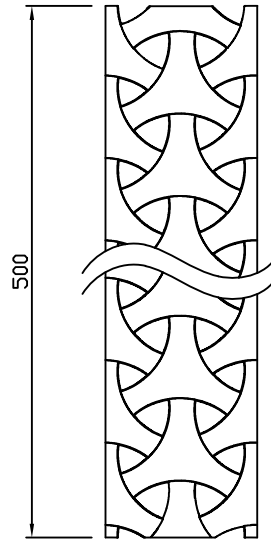

평면도
scale : None

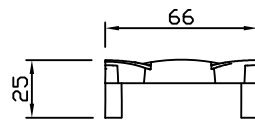

정면도
scale : None

연결소켓

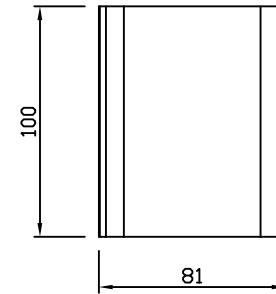

평면도
scale : None



정면도
scale : None

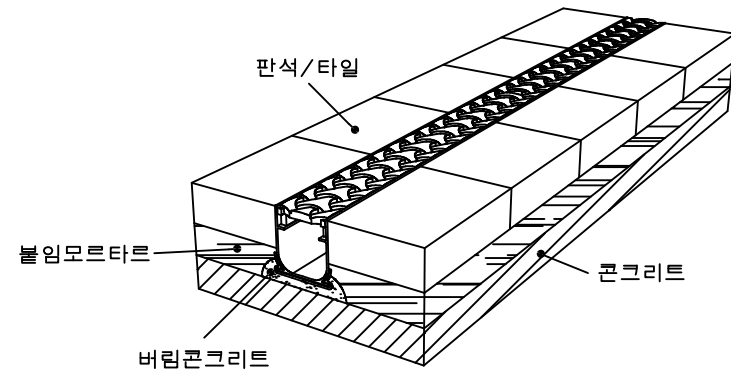

설치예시도 1
scale : None

PROJECT TITLE	물도랑	SUBJECT TITLE		DATE	
MATERIAL		WEIGHT		SIZE	73*81*3000
			Kg		